

SNOWMAN

30 piezas. Dimensiones : Alt. 30 x Anch. 15 x Prof. 15 cm

Dificultad:     



NECESITAS

Impresora
Hojas A4
Regla
Cuter
Pegamento

ARMADO

- 1.- Imprime la plantilla*
- 2.- Corta por toda la línea continua
- 3.- Marca y dobla las líneas punteadas, esto puedes hacerlo con algo que tenga punta fina pero que no corte

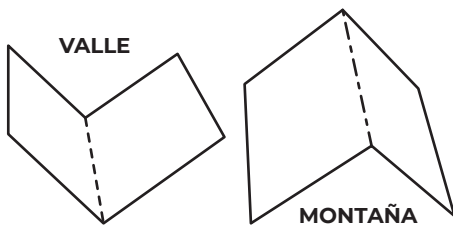

- 4.- Une con el pegamento las pestañas con sus respectivos números

Obtén descuentos en tu próxima compra. Solo toma fotos de tu creación, súbela en instagram o tiktok y etiquétanos: @the_paperking

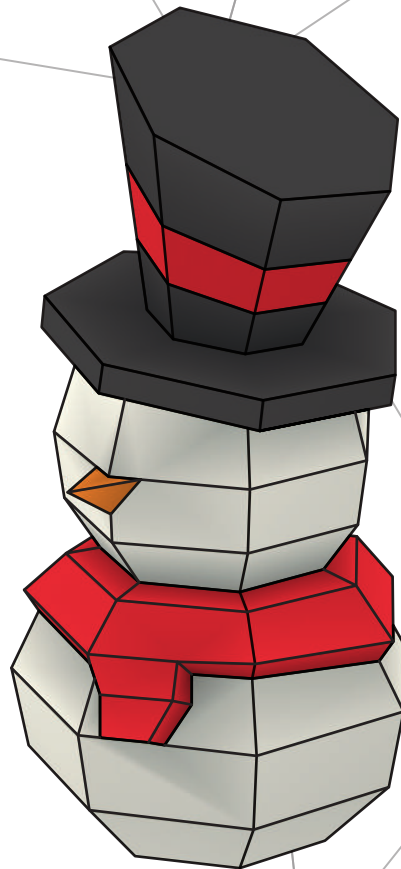

***Importante: Imprime esta plantilla en hojas de 180 a 300 gr**

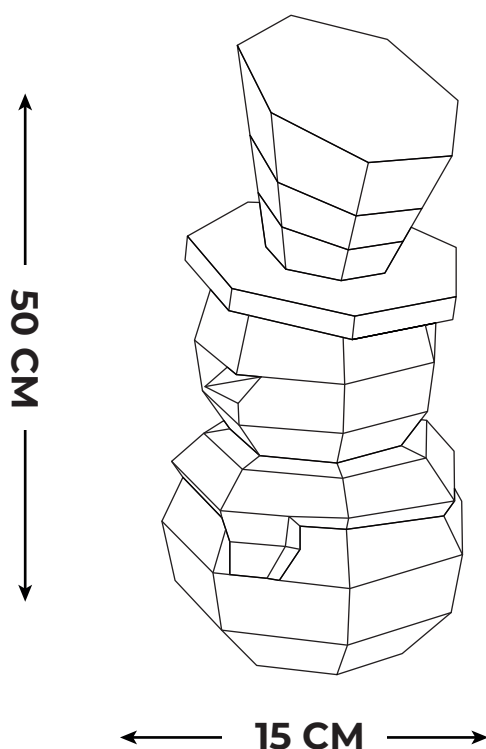

El modelo esta diseñado para que toda la impresión quede por dentro del modelo.

El color de la hoja se indica en la misma.

15 CM



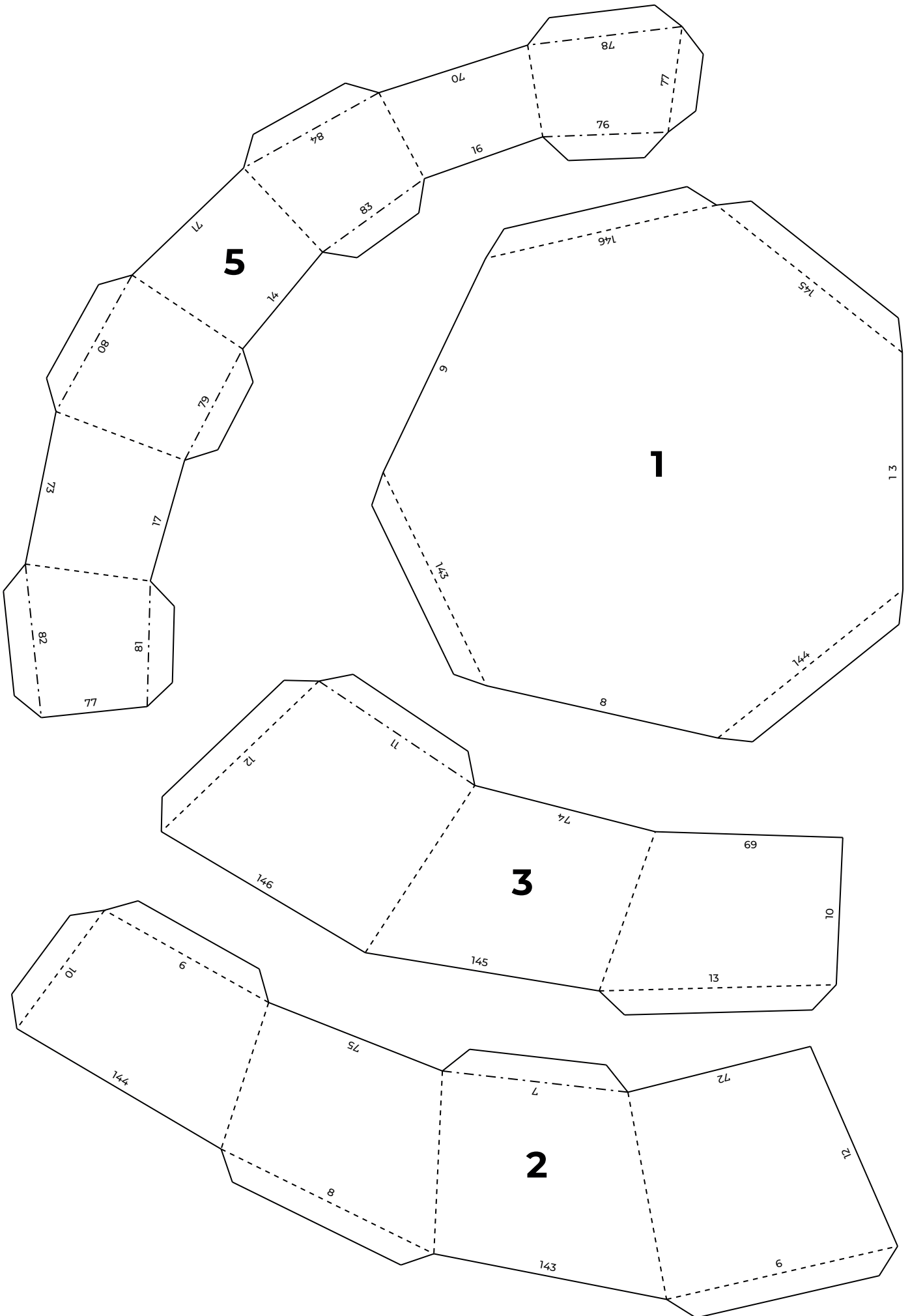

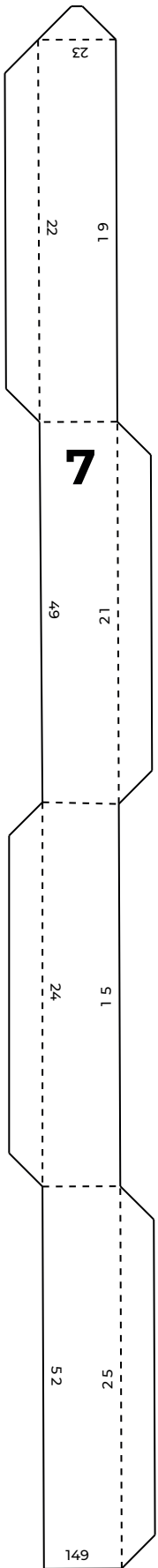

7

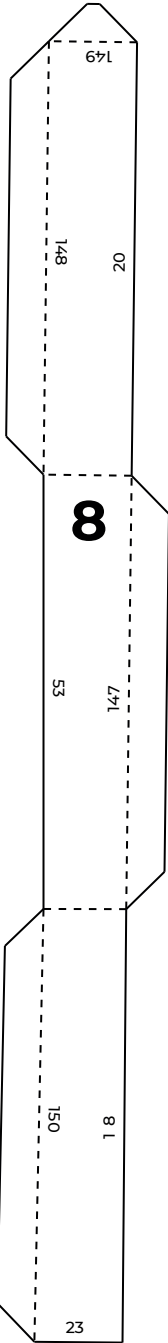

8

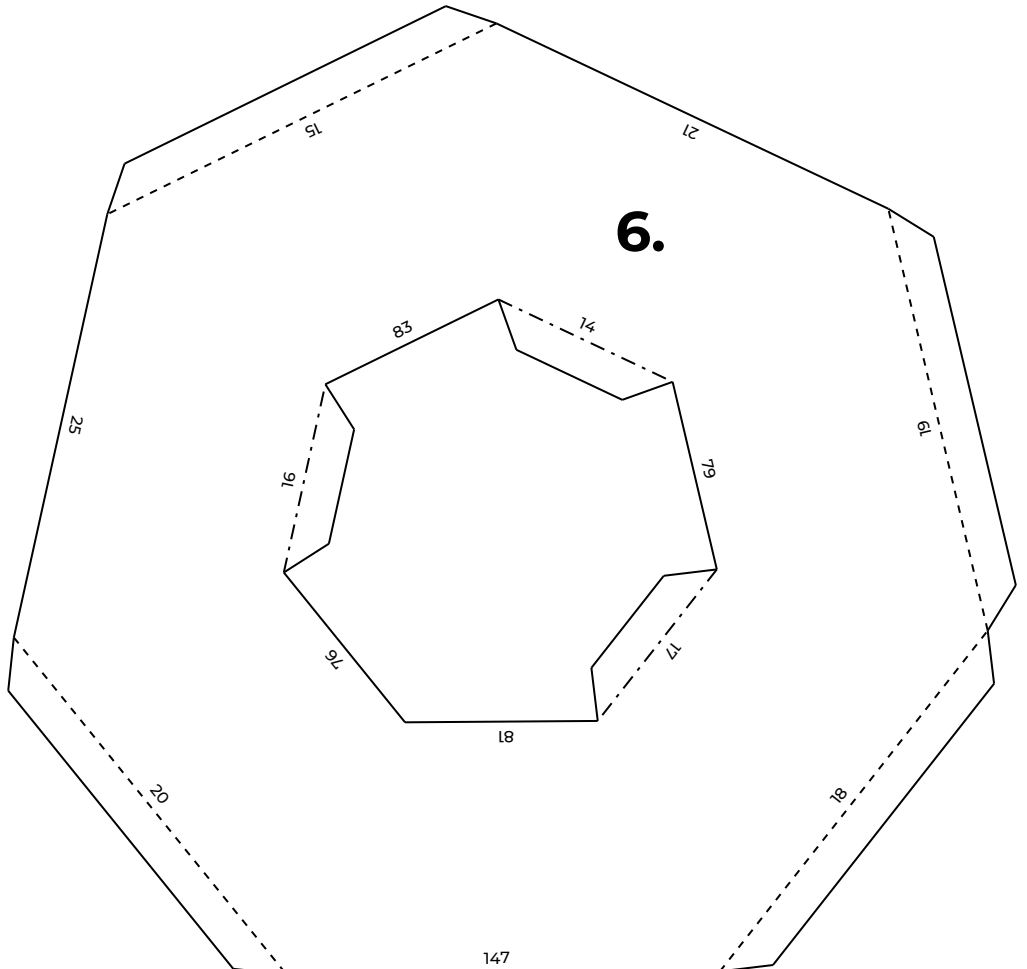

6.

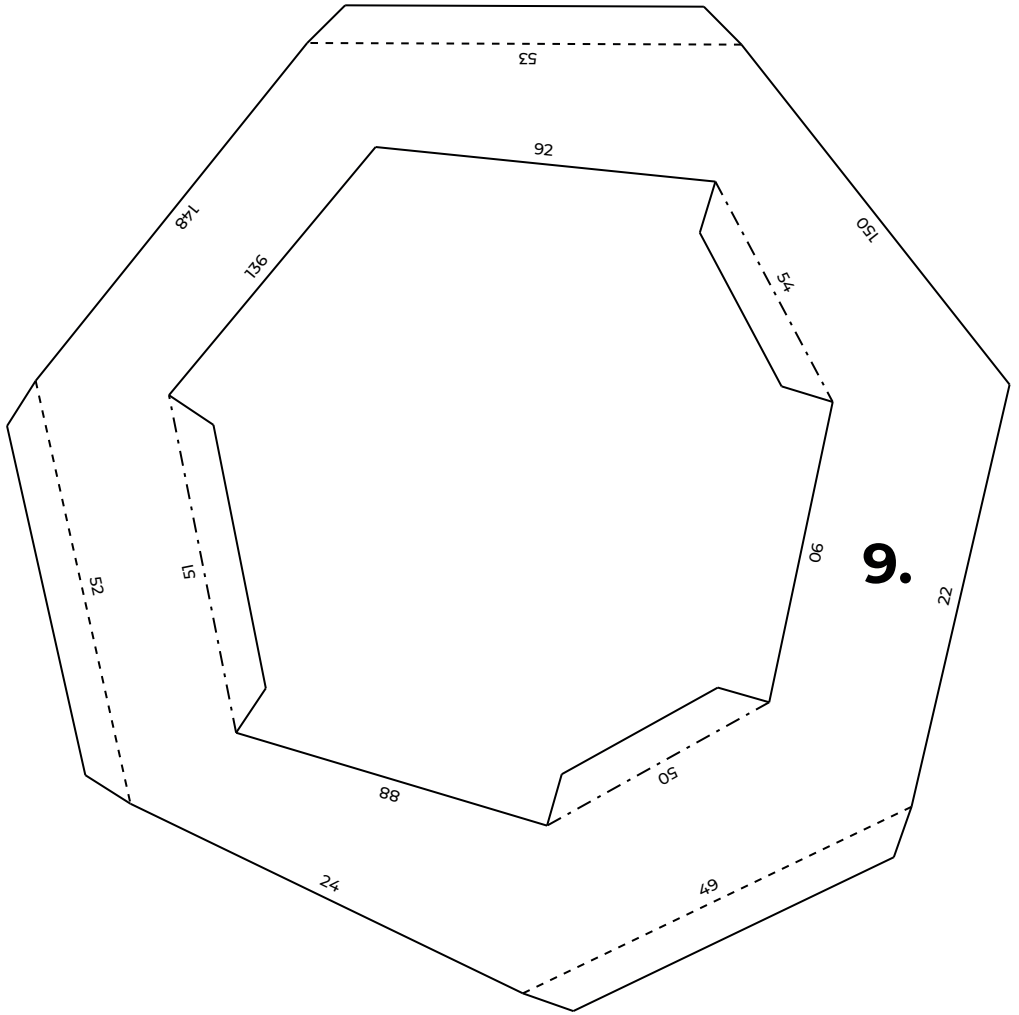

9.



